



epirefrigeration

KREA 260.9

CHEST FREEZER



FEATURES INCLUDE:

- Large storage capacity
- Electronic temperature control
- LED lighting
- Anti-fog doors

- High efficiency fan motor
- Optional customized graphic and coloured bumper
- Optional basket support

BAKER

REFRIGERATION

Visit our website www.ajbaker.com.au or email us at email@ajbaker.com.au

Image used for illustration only.

KREA 260.9

CHEST FREEZER

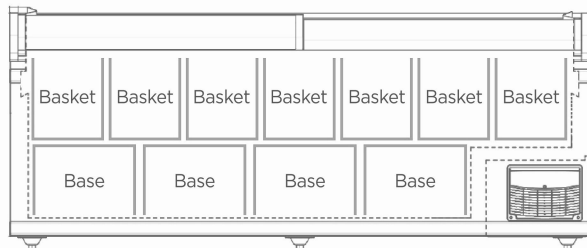
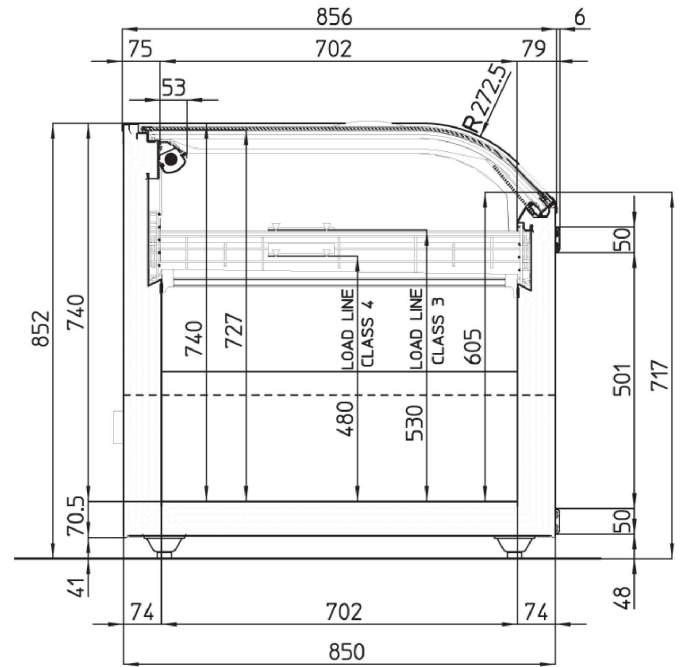
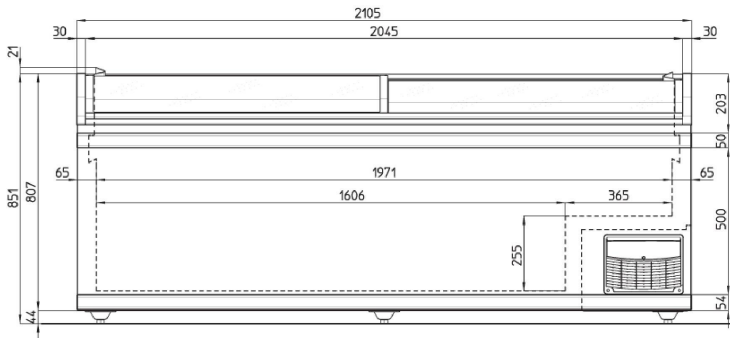

Base & Basket Layout

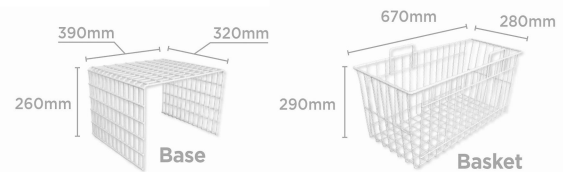

KREA	260.9
* Operating temp. (°C)	-25/-18
Refrigeration	Static/R290
Defrost	Semi-automatic
Power supply	230V/1Ph/10 Amp plug
Operating current (Amp)	3.1-3.5 (defrost)
Nominal power (W)	520-710 (defrost)
Energy consumption (kWh/24h)	7.7
Net Volume (LT)	767
Total length (mm)	2505
Total height (mm)	872
Total depth (mm)	899
Weight with packaging (kg)	202
Weight w/o packaging (kg)	162

Climate Class 3 (25°C, 60% hr)