

OPEN AIR SALAD TABLE

FTTB-1500

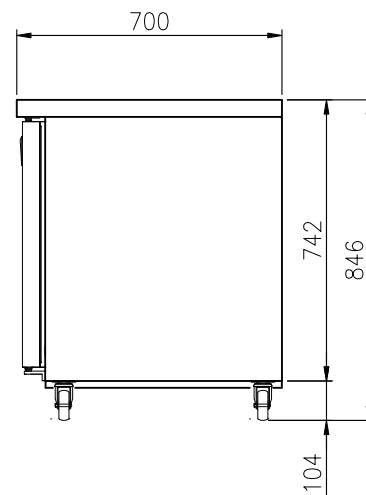
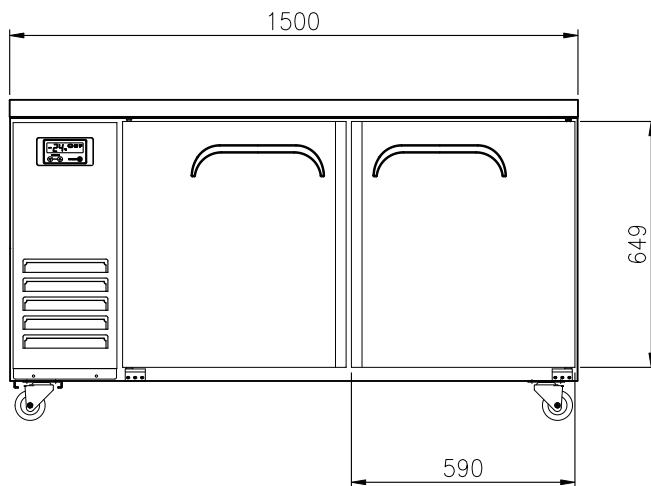
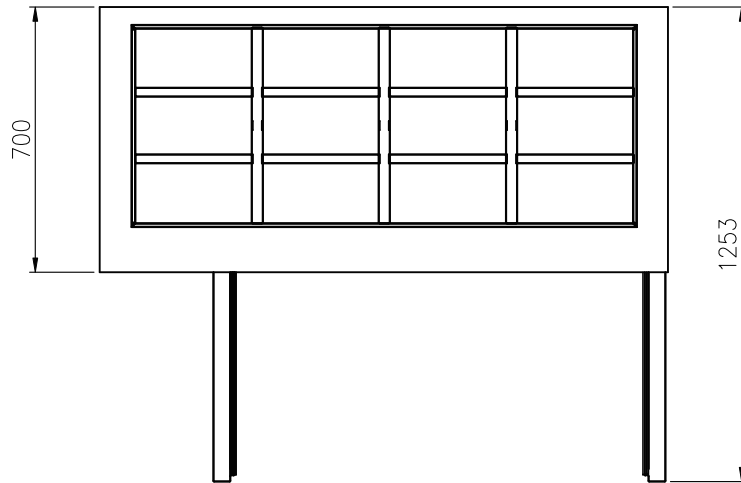

FEATURES

- Auto-closing doors & stopper
- Magnetic door gasket
- Locking dividers
- PVC coated sturdy wire shelves
- Digital temperature control & monitor system
- 3" casters (brake at front)
- Accommodates full-size pan with any depth (* pans are optional)
- Stainless steel finished top, front, sides and doors

TEMPERATURE

0°C ~ 5°C

OPTIONAL MODELS

- Custom-made top
- 4" or 5" casters
- Leg model available

Model	Capacity (l)	Exterior Dimension (mm)			Net Weight (kg)	Gross Weight (kg)	Power Supply	Amps	Voltage (V/Hz/Ø)	Watt	HP	Refrigerant	No. Door	No. Pans (1/3")
		W	D	H										
FTTB-1500R	336	1,500	700	846	81	91	10A	2.0	240/50/1	340	1/3	R-134a	2	12

* The heights include the 3" caster (104mm)
 * Design and specifications subject to change without notice
 * Actual shipping weight may differ due to extra packing materials for product protection.