

DUAL TEMPERATURE UNDERBENCH

FT-1500RF

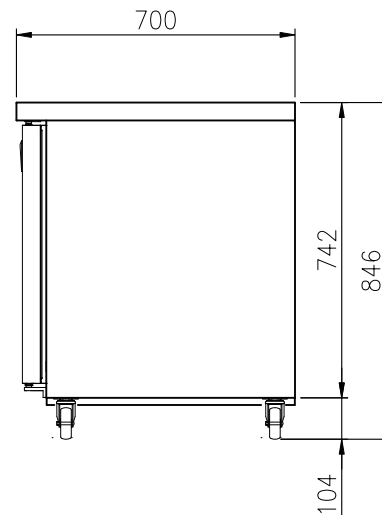
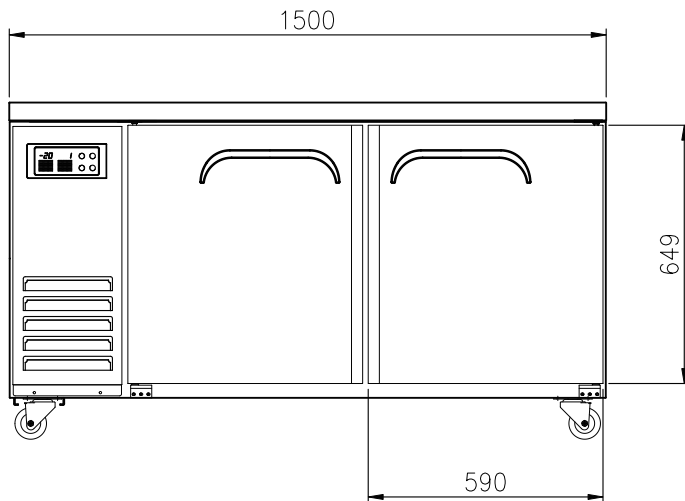
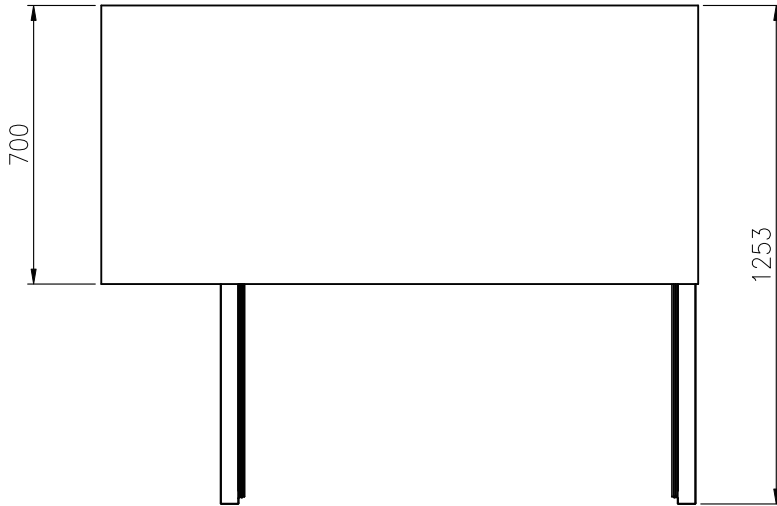

FEATURES

- Auto-closing doors & stopper
- Door pressure release device
- Magnetic door gasket
- Extra-large internal capacity
- Front breating
- Digital temperature control & monitor system
- 4" casters (brakes at front)
- Fully stainless steel finished cabinet
- PE coated sturdy wire shelves

TEMPERATURE

- Fridge: 0°C ~ 5°C
- Freezer: -18°C

OPTIONAL MODELS

- Leg model
- 3" or 5" casters

Model	Capacity (ℓ)		Exterior Dimension (mm)			Net Weight (kg)	Gross Weight (kg)	Power Supply	Amps	Voltage (V/Hz/Ø)	Watt	HP	Refrigerant	No. Doors
	Ref.	Fre.	W	D	H									
FT-1500RF	455	177	1,500	700	846	94	104	10A	3.0	240/50/1	390(D:620)	3/8	R-134a	2

* Exterior height includes 4" for caster or leg height.
 * Design and specifications subject to change without notice
 * Actual shipping weight may differ due to extra packing materials for product protection.