

FPT-44

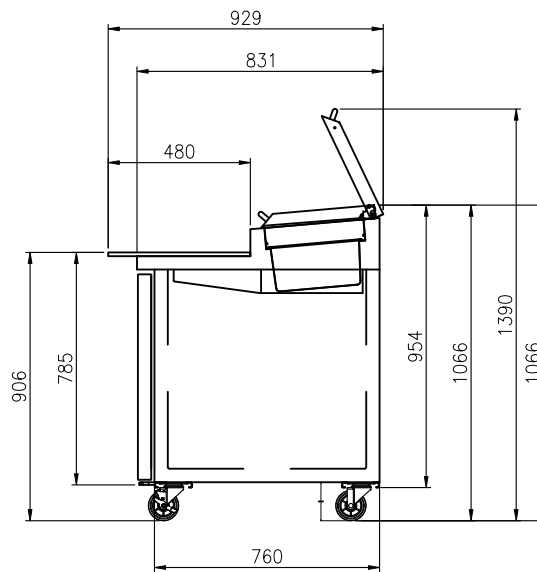
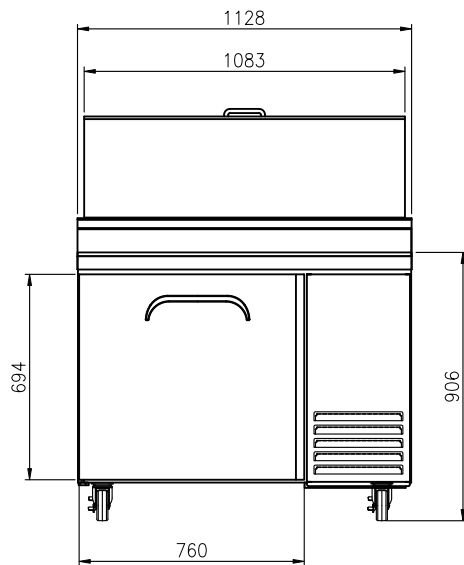
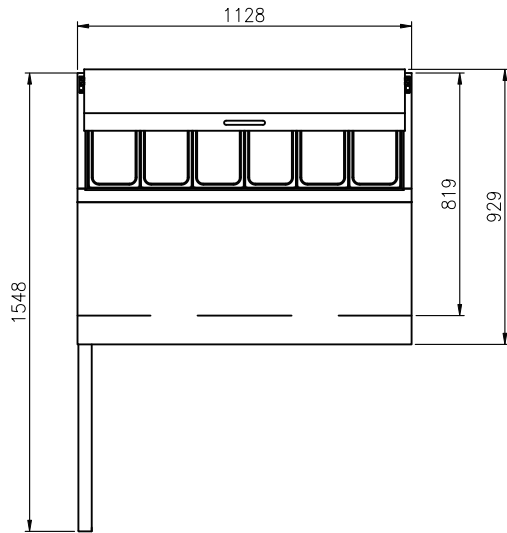

FEATURES

- Auto-closing doors & stopper
- Magnetic door gasket
- Stainless steel hood lid covers
- Locking dividers
- 380mm reversible cutting board
- PE coated sturdy wire shelves
- Rear-mount compressor for enhanced airflow
- 4" casters (brakes at front)
- Accommodates 15cm deep pan (* pans are optional)
- Stainless steel finished top, front, sides and doors

TEMPERATURE

- 0°C ~ 5°C

OPTIONAL MODELS

- Drawer mixed model (custom-made)
- 3" or 5" casters

Model	Capacity (ℓ)	Exterior Dimension (mm)			Net Weight (kg)	Gross Weight (kg)	Power Supply	Amps	Voltage (V/Hz/Ø)	Watt	HP	Refrigerant	No. Door/Drawer	No. Pans (1/3")
		W	D	H										
FPT-44	320	1,128	929	1,066	130	138	10A	3.2	240/50/1	380	3/8	R-134a	1	6

* Exterior height includes 4" for caster height.
 * Design and specifications subject to change without notice.
 * Actual shipping weight may differ due to extra packing materials for product protection.