

REFRIGERATION CHEF BASE

FDC-1500

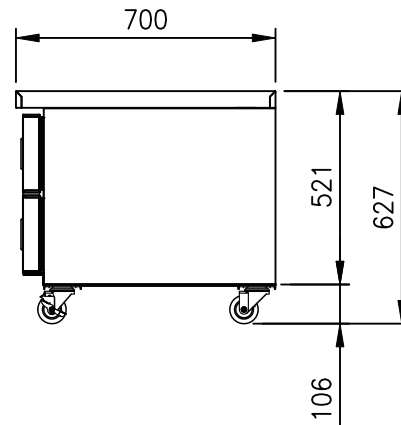
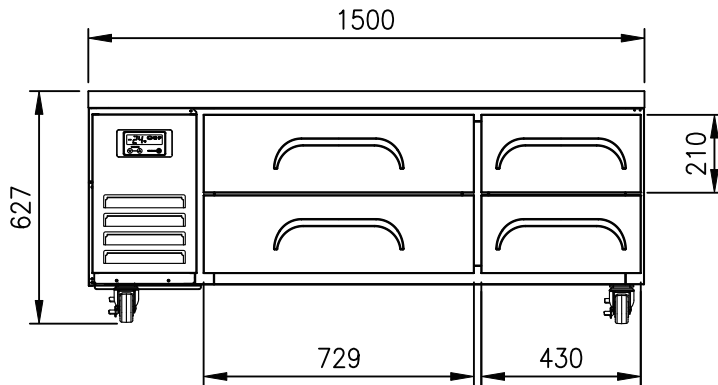
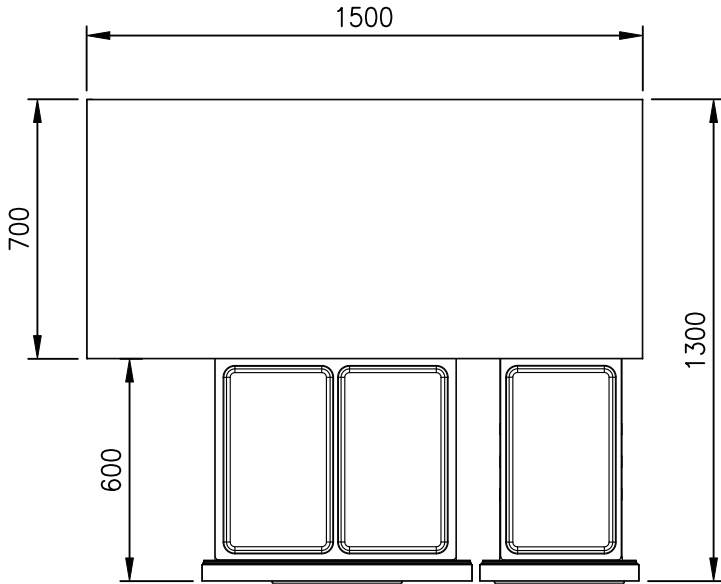

FEATURES

- Telescoping drawer slide
- Drawer can hold up to 40kg
- Accommodates full-size pan up to 15cm depth (* pans are optional)
- Digital temperature control & monitor system
- 3" casters (brakes at front)
- Fully stainless steel finished cabinet

TEMPERATURE

0°C ~ 5°C

OPTIONAL MODELS

- 4" or 5" casters
- Leg model available

Model	Capacity (ℓ)	Exterior Dimension (mm)			Net Weight (kg)	Amps	Power Supply	Voltage (V/Hz/Ø)	Watt	HP	Refrigerant	No. Drawer	No. Pan (1/1")
		W	D	H									
FDC-1500	257	1,500	700	627	116	1.8	10A	240/50/1	320	1/5	R-134a	4	6

- * The heights include the 3" caster (106mm)
- * Design and specifications subject to change without notice
- * Actual shipping weight may differ due to extra packing materials for product protection.